



NiGLON

Industrial Accessories

IS404 Insulated Rotary Isolator

Technical Drawing

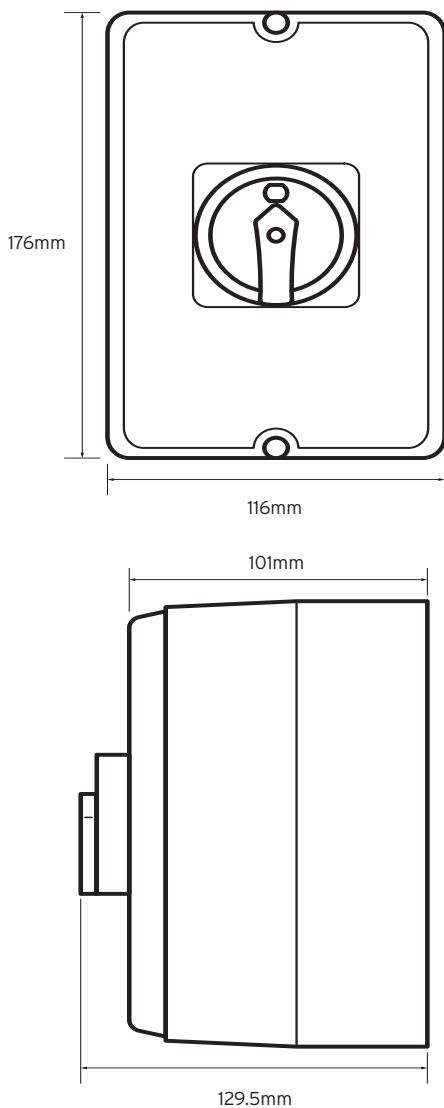

Technical Specifications

Standards	EN60947-3
Rated Current	40A
No. of Poles	4
Rated Insulation Voltage(V)	690V
Rated Operating Current(A)	40
AC-22A	40
AC-23A	40
AC-3	32
Rated Voltage(Ue)	440V
Rated Power Control(KW)	15
Rated short-time withstand current(Icw)	800A
Connect Wire	10mm ²
Screw Torque	1.2 N.m

Enclosure Characteristics

Overall Dimensions HxWxD	176x116x101mm
Depth with switch	129.5mm
Degree of IP	IP65
Colour	Upper cover RAL9002, Bottom case RAL 7031

Wiring Diagram

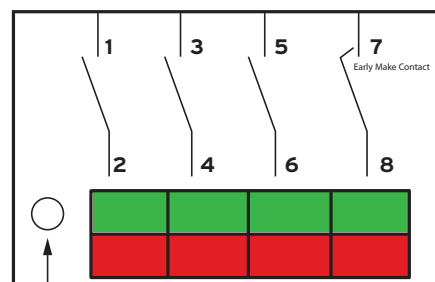

Note 7 = Early Make Contact